

INSTRUCTION MANUAL



1 INTRODUCTION

Thank you for buying HUBSAN products. The Q4 Nano quad is designed as an easy-to-use, full-featured RC model capable of hovering, fast forward, and aerobatic flight maneuvers. Please read the manual carefully and follow all instructions in it. Be sure to retain the manual for future reference, routine maintenance, and tuning.

2 SAFETY NOTES

- 2.1 Important Notes**
This RC Nano quad is not a toy.
Any improper use of this product will result in serious injury. Be aware of your personal safety, safety of others and your surrounding environment.
We recommend beginners learn to fly with more experienced pilots playing nearby before attempting to fly the Q4 for the first time.
- 2.2 Caution**
The Q4 Nano quad has parts that move at high speed, which poses a certain degree of danger.
Choose a wide open space without obstacles. Do not operate the Q4 near buildings, crowds of people, high voltage cables, or trees to ensure the safety of yourself, others and your model.
Improper operation may cause damage to people and property.
- 2.3 LiPo Battery Safety Notes**
The Q4 is powered by a Lithium-Polymer (LiPo) battery.
To avoid risk of fire or damage, never recharge your battery while it is inserted in the Q4.
If you do not plan to fly the Q4 for a week or more, store the battery approximately 50% charged to maintain battery performance and life.

SAFETY ADVISORY NOTICE Lithium-Polymer (LiPo) Batteries

- LiPo batteries are different from conventional batteries in that their chemical contents are encased in a relatively lightweight foil packaging. This has the advantage of significantly reducing their weight, but does make them more susceptible to damage if roughly or inappropriately handled. As with all batteries, there is a risk of fire or explosion if safety practices are ignored:
- Charge and store LiPo batteries in a location where a battery fire or explosion (including smoke hazard) will not endanger life or property.
 - Keep LiPo batteries away from children and animals.
 - Never charge the LiPo battery that has ballooned or swelled.
 - Never charge the LiPo battery that has been punctured or damaged.
 - After a crash, inspect the battery pack for the sign of damage. Discard in accordance with your country's recycling laws.
 - Never charge the LiPo battery in a moving vehicle.
 - Never overcharge the LiPo battery.
 - Never leave the LiPo battery unattended during recharging.
 - Do not charge LiPo batteries near flammable materials or liquids.
 - Ensure that charging leads are connected correctly. Reverse polarity charging can lead to battery damage or a fire or explosion.
 - Have a suitable fire extinguisher (electrical type) OR a large bucket of dry sand near the charging area. Do not try to extinguish electrical (LiPo) battery fires with water.
 - Reduce risks from fire/explosion by storing and charging LiPo batteries inside a suitable container.
 - Protect your LiPo battery from accidental damage during storage and transportation. (Do not put battery packs in pockets or bags where they can short circuit or can come into contact with sharp or metallic objects).
 - If your LiPo battery is subjected to a shock (such as a crash), place it in a metal container and observe for signs of swelling or heating for at least 30 minutes.
 - Do not attempt to disassemble or modify or repair the LiPo battery.

2.4 Prevent Moisture

The Q4 contains many precision electrical components. Store the battery and the Q4 in a dry area at room temperature. Exposure to water or moisture may cause malfunction resulting in loss of responsiveness, or a crash.

2.5 Proper Operation

For safety only use the included HUBSAN spare parts for replacement.

2.6 Always Be Aware of the Rotating Blades

When in operation, the main and tail rotor blades will be spinning at high speed. The blades are capable of inflicting serious body injury or property damage. Be careful to keep your body and loose clothing away from the blades. Never take your eyes off the Q4 or leave it unattended while it is turned on. Stop operating immediately if the Q4 flies out of your view. Once landed, immediately turn off the Q4 and transmitter.

2.7 Avoid Flying Alone

Beginners should avoid flying alone when learning flight skills. We recommend flying with an experienced pilot nearby in case you need help.

3 SAFETY CHECK BEFORE FLYING

- CAREFULLY INSPECT THE Q4 BEFORE EVERY FLIGHT**
- Before operation, check the batteries of the transmitter and Q4 are charged for the flight.
 - Before turning on the transmitter, check that the throttle stick is pulled completely backward (down position).
 - Carefully check rotor blades and rotor holders. Broken parts will pose risk of injury and hazard.
 - Check the battery and power plug are securely fastened. Severe vibration during flight may detach the plug and result in loss of control.
 - When turning on the unit, always turn on the transmitter first, and then turn on the Q4. To power off, always turn off the Q4 first and then the transmitter. Improper procedure may cause loss of control of the nano quad.

4 Nano quad

4.1 Charge the Q4
Connect the battery with USB charger, then connect the USB charger to a computer or other USB connector, such as a smartphone charger. The LED lights up while charging and turns off when charging is complete. The voltage of the USB is +5±0.5V.
The nano quad is equipped with a 3.7V 100mAh Lipo battery



4.2 Power on the Q4



5 TRANSMITTER

5.1 Identification and functions of the Main Menu TRANSMITTER

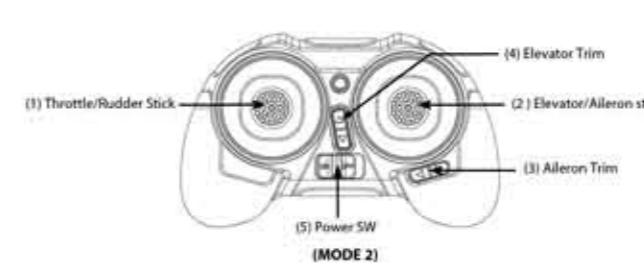
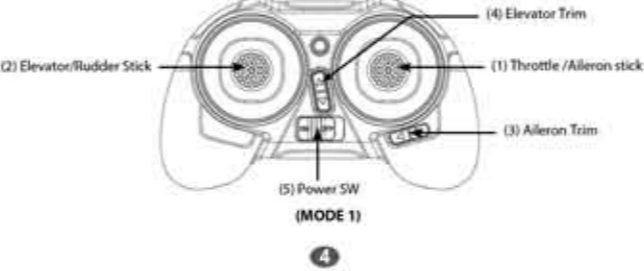

5.2 TRANSMITTER STICK CALIBRATION

Mode 2: Push both sticks to the upper left position and hold, then power on the transmitter. Rotate both sticks twice. Hold down any trim until the LED on the transmitter blinks red, indicating successful calibration.

Mode 1: Push the left stick to the upper left position and right stick to the upper right position and hold, then power on the transmitter. Rotate both sticks twice. Hold down any trim until the LED on the transmitter blinks red, indicating successful calibration.

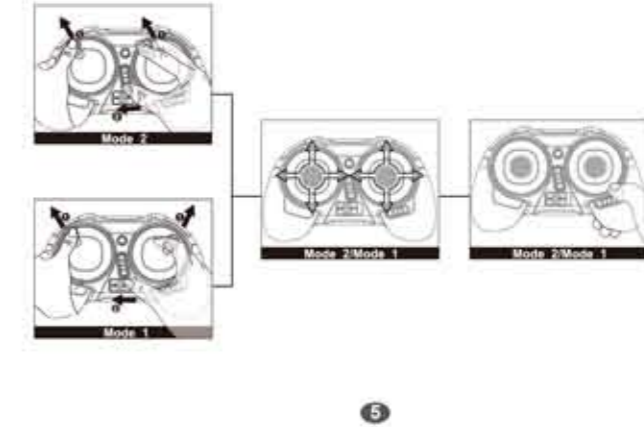

6 START TO FLY

6.1 Power-On (Fail-safe) Procedure
Your Q4's flight controller is designed with a Power-On safety feature that ensures the Q4's motor will not start unless it detects a suitable radio-control signal when the Q4 and the transmitter both power on and paired.

6.1.1 Make sure the throttle stick is in the full down position.

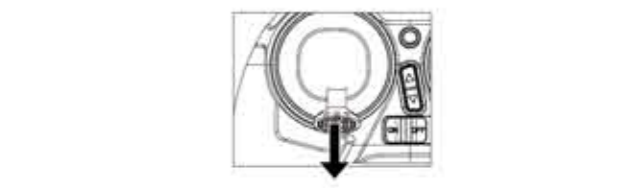

6.1.2 Power on the transmitter and the red LED will blink. Do not move any other stick or trim before the transmitter and Q4 finish pairing, or the Q4 will drift. The transmitter LED will turn green after pairing is successfully completed.



6.2 Transmitter Sticks And Q4 Control Responses
CAUTION: To avoid loss of control, always move the transmitter sticks slowly. Be aware that control inputs will reduce available lift. Be ready to use a little extra throttle to maintain height during maneuvers.

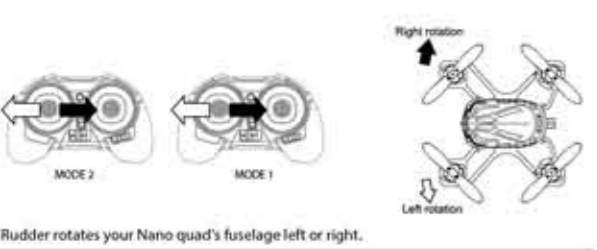
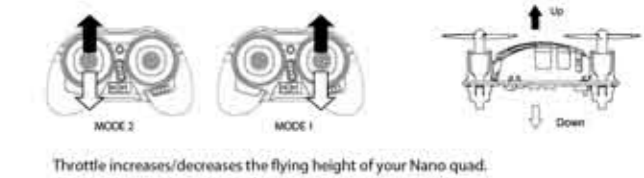

Rudder rotates your Nano quad's fuselage left or right.

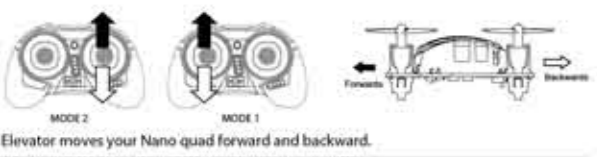

Elevator moves your Nano quad forward and backward.

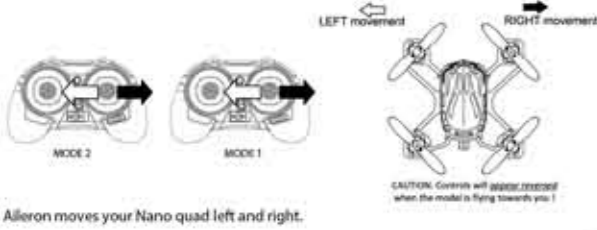

Aileron moves your Nano quad left and right.

7 Sensitivity Setup

The nano Q4 can perform in 3 stages: low-middle-high
Click the elevator sticker to enter the 3 different stages:
The LED on the transmitter is Solid Green = the Q4 is in the low stage (about 30% sensitivity)
The LED on the transmitter is blinking green = the Q4 is in the middle stage (about 60% sensitivity)
The LED on the transmitter is blinking orange = the Q4 is in the high stage (about 100% sensitivity)
Press (a)Elevator Trim/(b)Aileron Trim to change the sensitivity values and then hold down the elevator stick for 1 second to confirm or exit. The Q4 will be more sensitive and responsive with the correspondence values.

8 Aerial Flip Tips

The flip will only work in HIGH STAGE, press the elevator stick to switch into the High Stage.

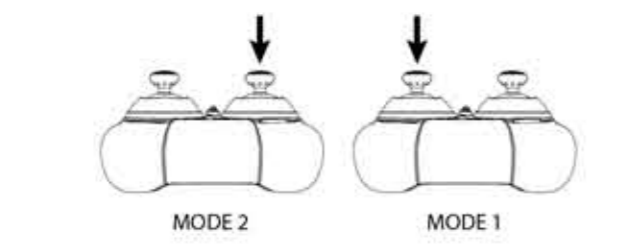

Press the Throttle stick to enter Flip Mode, indicated by two "beeps". Press the Throttle stick again to exit Flip Mode, indicated by one "beep".

! For proper flip execution, make sure the Q4 is close to level, within a 30° angle with the ground, and add throttle to climb before you perform a flip.

8.1 Left Flip



8.2 Right Flip

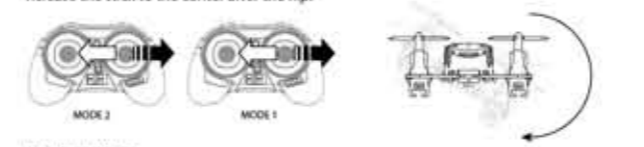

8.3 Forward Flip



8.4 Backward Flip

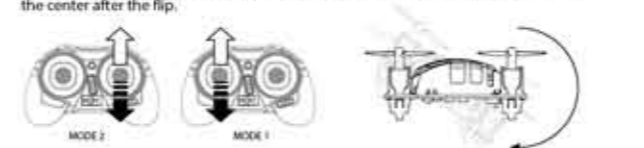

! Note: when the Q4 battery is low, performing flip is not possible.

9 REPLACING PROPELLERS

The Q4's propellers are not identical. Each propeller is labeled with an A or B. When installing replacement propellers, be certain to install as shown below. The Q4 will not fly, and will flip and crash if the propellers are not installed correctly.

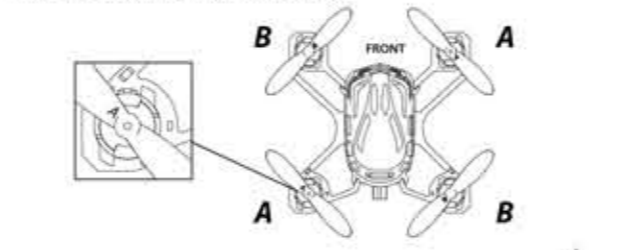

Install Propellers: Pinch the propeller hub, align the hole to the motor shaft, and press it straight down firmly but gently.



BLADE GUARD

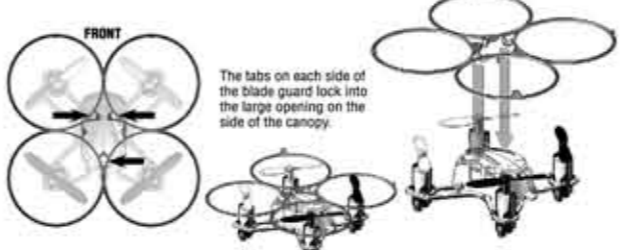

Exploded View

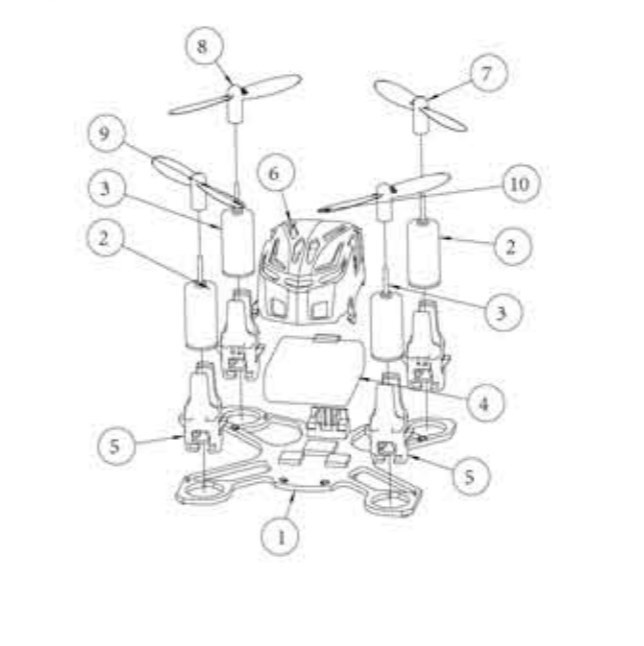

No	PART NAME	QTY	No	PART NAME	QTY
1	Mini RX	1	6	Shell	1
2	612 motor (clockwise)	2	7	White blade A	1
3	612 motor (counterclockwise)	2	8	White blade B	1
4	Li-po battery	1	9	Black blade A	1
5	motor supportor	4	10	Black blade B	1

H111 TROUBLESHOOTING

- Transmitter and Q4 will do not pair.
Throttle position needs to be fully minimized. Please do not move the transmitter sticks or trims during initial power-on binding.
- Gyro not working well
(1) Battery voltage too low.
(2) Re-bind
(3) Land on to the ground with the throttle fully minimized for 3 seconds and take off again.
- Unable to Flip
(1) Press the Elevator stick briefly to switch into high stage(transmitter LED blinks orange, three "Beep"). Please check Elevator 7. Sensitivity Setup;
(2) Press the throttle stick to turn off the anti-flip;
(3) Lipo power is too low and needs to be re charged.
- Nano quad is shaking or oscillating with noise.
Please check to see that the motors, canopy, body and props are all properly positioned.
- Switching between Elevator and high rates on the transmitter is not very user-friendly.
Press the elevator stick briefly to switch into high stage(transmitter LED blinks orange, three "Beep").
- Can not take off.
(1) Wrong installation of the props. Props are marked with "A"(CW) and "B"(CCW). Please check the pictures below for the correct order.
(2) Wrong installation of motors. Please check to make sure that each motor is installed in its correct position. There are two different types of motors with different motor wire colors. Please check the pictures below for the correct order.
- One or more motors stop working
(1) Motor is damaged. Replace the motor.
(2) The motor connection(s) are disconnected. Resolder.
(3) An FET on the flight controller looks burnt. Replace the flight controller.
- The Q4 always drifts to one direction.
Calibrate the accelerometer as follows:

H111 SPARE PART CHART

